



















































CLAD ULTIMATE DOUBLE HUNG PICTURE UNIT - NEXT GENERATION

M.O. (mm)	3-5 3/4 (1060)	4-1 3/4 (1264)	4-5 3/4 (1365)	5-1 3/4 (1568)	5-9 3/4 (1772)
R.O. (mm)	3-6 1/4 (1073)	4-2 1/4 (1276)	4-6 1/4 (1378)	5-2 1/4 (1581)	5-10 1/4 (1784)
Frame Size (mm)	3-5 1/4 (1048)	4-1 1/4 (1251)	4-5 1/4 (1353)	5-1 1/4 (1556)	5-9 1/4 (1759)
DLO (mm)	34 47/64 (882)	42 47/64 (1085)	46 47/64 (1187)	54 47/64 (1390)	62 47/64 (1594)

3-3 3/4 (1010) 3-4 (1016) 3-3 1/2 (1003) 3-1 1/2 (998)	 CUDHP-NG4038	 CUDHP-NG4838	 CUDHP-NG5238	 CUDHP-NG6038	 CUDHP-NG6838
3-7 3/4 (1111) 3-8 (1118) 3-7 1/2 (1105) 3-5 1/2 (1090)	 CUDHP-NG4042	 CUDHP-NG4842	 CUDHP-NG5242	 CUDHP-NG6042	 CUDHP-NG6842
4-0 5/8 (1235) 4-0 (1219) 3-11/2 (1207) 3-9 1/2 (1190)	 CUDHP-NG4046	 CUDHP-NG4846	 CUDHP-NG5246	 CUDHP-NG6046	 CUDHP-NG6846
4-4 5/8 (1337) 4-4 (1321) 4-3 1/2 (1308) 4-1 1/2 (1293)	 CUDHP-NG4050	 CUDHP-NG4850	 CUDHP-NG5250	 CUDHP-NG6050	 CUDHP-NG6850
4-8 5/8 (1438) 4-8 (1422) 4-7 1/2 (1410) 4-5 1/2 (1395)	 CUDHP-NG4054	 CUDHP-NG4854	 CUDHP-NG5254	 CUDHP-NG6054	 CUDHP-NG6854
5-0 5/8 (1540) 5-0 (1524) 4-11/2 (1511) 4-9 1/2 (1496)	 CUDHP-NG4058	 CUDHP-NG4858	 CUDHP-NG5258	 CUDHP-NG6058	 CUDHP-NG6858
5-4 5/8 (1641) 5-4 (1626) 5-3 1/2 (1613) 5-1 1/2 (1598)	 CUDHP-NG4062	 CUDHP-NG4862	 CUDHP-NG5262	 CUDHP-NG6062	 CUDHP-NG6862
5-8 5/8 (1743) 5-8 (1727) 5-7 1/2 (1715) 5-5 1/2 (1700)	 CUDHP-NG4066	 CUDHP-NG4866	 CUDHP-NG5266	 CUDHP-NG6066	 CUDHP-NG6866
6-0 5/8 (1845) 6-0 (1829) 5-11/2 (1816) 5-9 1/2 (1801)	 CUDHP-NG4070	 CUDHP-NG4870	 CUDHP-NG5270	 CUDHP-NG6070	 CUDHP-NG6870
6-4 5/8 (1946) 6-4 (1930) 6-3 1/2 (1918) 6-1 1/2 (1903)	 CUDHP-NG4074	 CUDHP-NG4874	 CUDHP-NG5274	 CUDHP-NG6074	 CUDHP-NG6874

CLAD ULTIMATE DOUBLE HUNG PICTURE UNIT - NEXT GENERATION

M.O. (mm)	3-5 3/4 (1060)	4-1 3/4 (1264)	4-5 3/4 (1365)	5-13/4 (1568)	5-9 3/4 (1772)
R.O. (mm)	3-6 1/4 (1073)	4-2 1/4 (1276)	4-6 1/4 (1378)	5-2 1/4 (1581)	5-10 1/4 (1784)
Frame Size (mm)	3-5 1/4 (1048)	4-1 1/4 (1251)	4-5 1/4 (1353)	5-11/4 (1556)	5-9 1/4 (1759)
DLO (mm)	34 47/64 (882)	42 47/64 (1085)	46 47/64 (1187)	54 47/64 (1390)	62 47/64 (1594)

6-8 5/8 (2048)					
CUDHP-NG4078	CUDHP-NG4878	CUDHP-NG5278	CUDHP-NG6078	CUDHP-NG6878	
6-8 (2032)					
6-7 1/2 (2019)					
71 2/164 (1814)	CUDHP-NG4086	CUDHP-NG4886	CUDHP-NG5286	CUDHP-NG6086	CUDHP-NG6886
7-4 5/8 (2251)					
7-4 (2235)					
7-3 1/2 (2223)					
79 27/64 (2017)	CUDHP-NG4090	CUDHP-NG4890	CUDHP-NG5290	CUDHP-NG6090	CUDHP-NG6890
7-8 5/8 (2353)					
7-8 (2337)					
7-7 1/2 (2324)					
83 27/64 (2119)					

CONSTRUCTION DETAILS

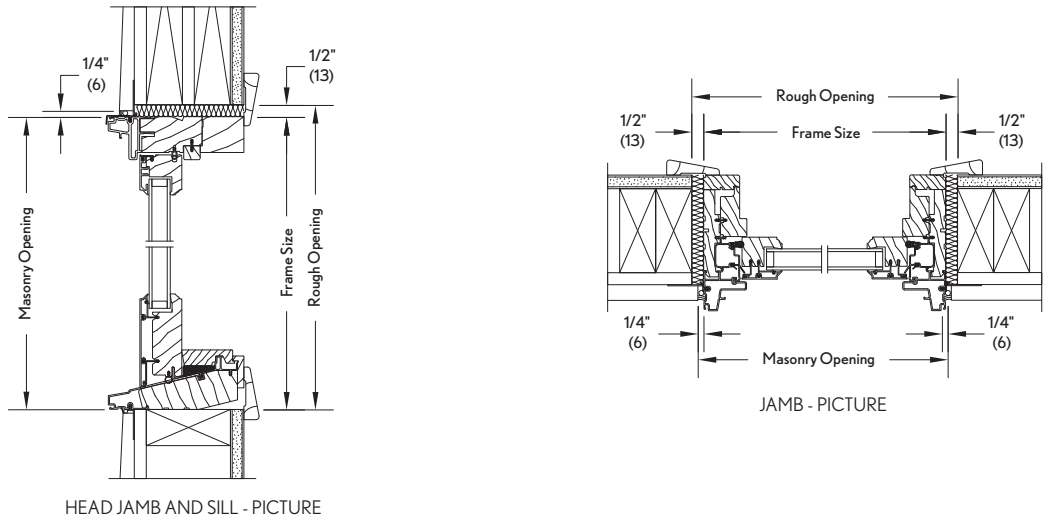

NOTES:

- Please contact your local Marvin® representative for masonry openings that include casings and subsills.

Clad Ultimate Double Hung Picture - Next Generation: **CUDHP-NG**